

















# PARTY TELT PVC 4X4 4X6 4X8 4X10

Artikel-nummer		Beskrivelse	Antal	Antal	Antal	Antal
		Model	4x4m	4x6m	4x8m	4x10m
1		Galvaniseret rør diameter 38mm 2160mm	6	8	10	12
2		Galvaniseret rør diameter 38mm 1940mm	6	9	12	15
3		Galvaniseret rør diameter 38mm 1920mm	6	8	10	12
4		3-vejs samling	6	6	6	6
5		4-vejs samling	3	6	9	12
6		Fod	6	8	10	12
A		Jordanker	4	4	4	4
B		Pløk, lang	6	8	10	12
C		Pløk, kort	26	34	40	56
D		Bardun	4	4	4	4
E		Elastik strop	66	84	102	120
F		Elastik strop	18	18	18	18
G		Tag dug	1	1	1	1

H		Skrue				
I		Sidevæg	4	6	8	10
J		Gavl	2	2	2	2

**1.** Monter alle rør og samlinger som vist på illustrationen nedenfor. Spænd fast med hjælp af fingerskruerne (del H) i alle samlingerne.

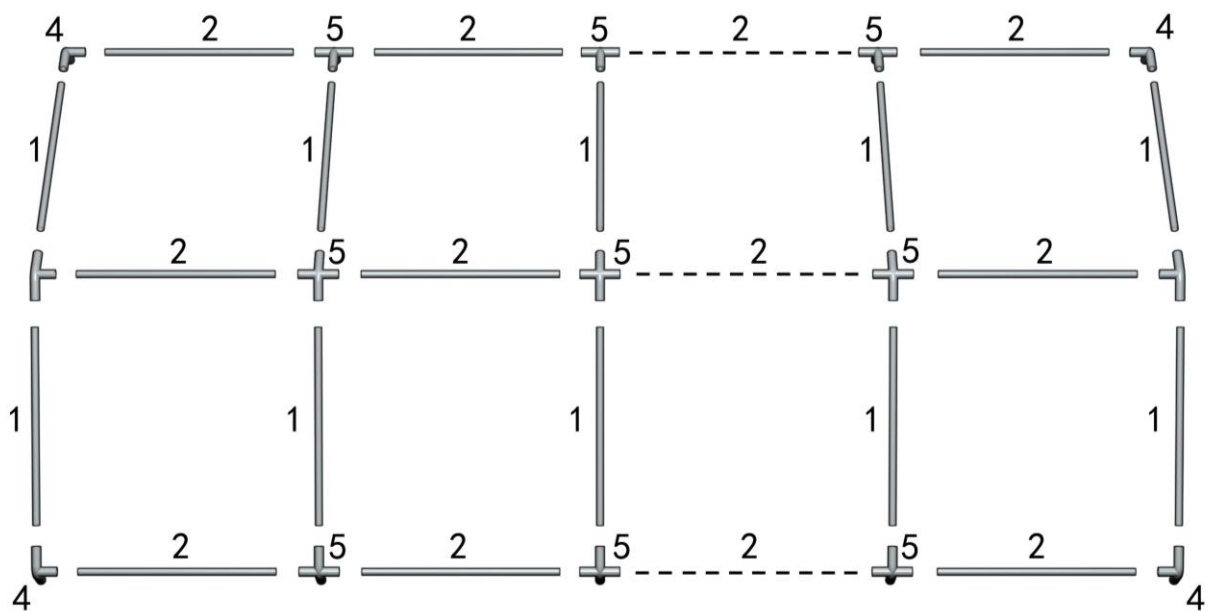

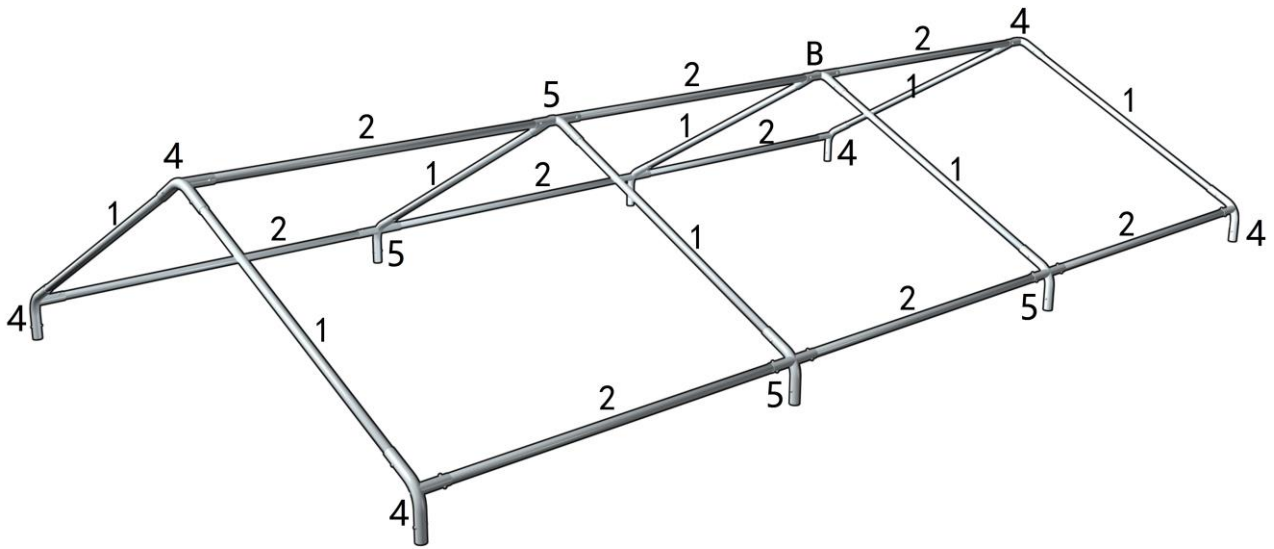

**2.** Løft ene langside og monter rør nr 3.

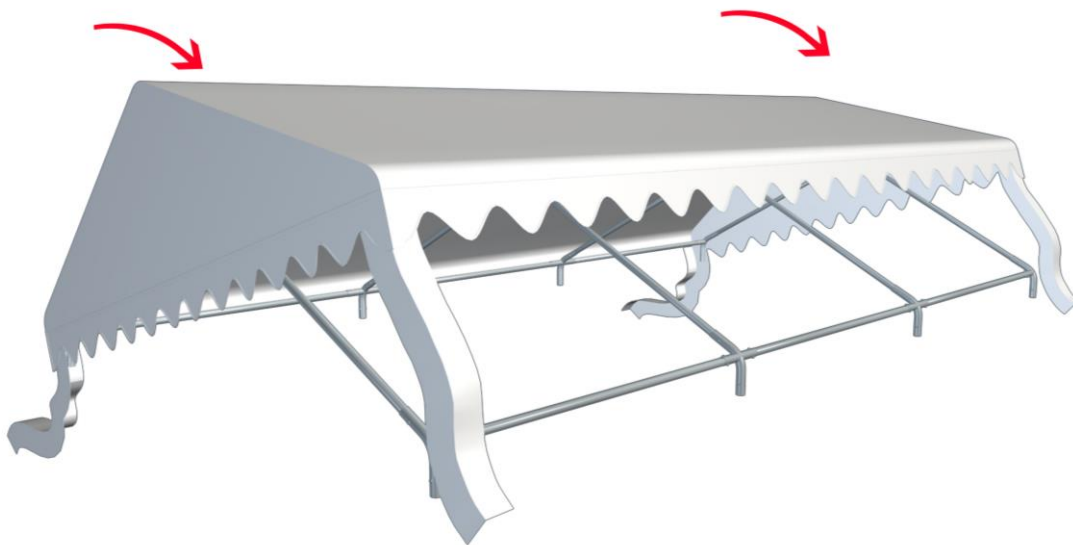

**3.** Læg tagdugen på.

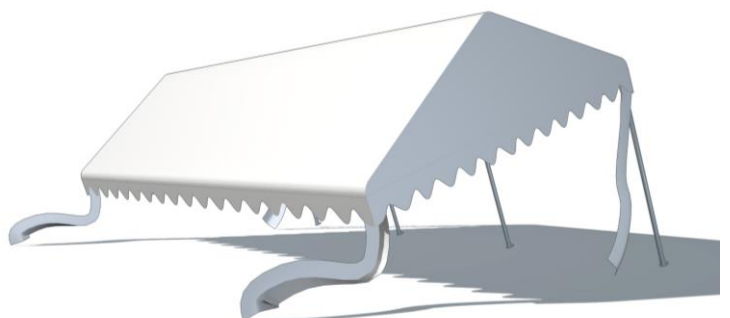
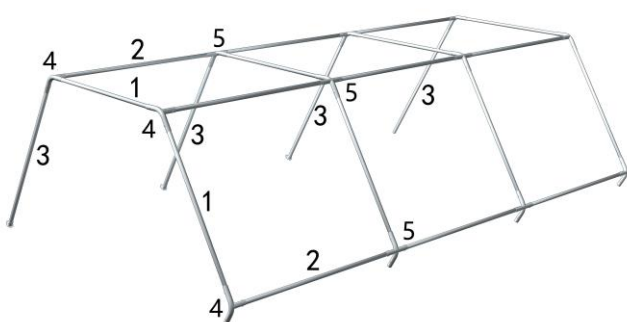

- 4.** Løft den anden langside og monter resterende rør nr 3. Sæt herefter alle fødder på plads (del 6).

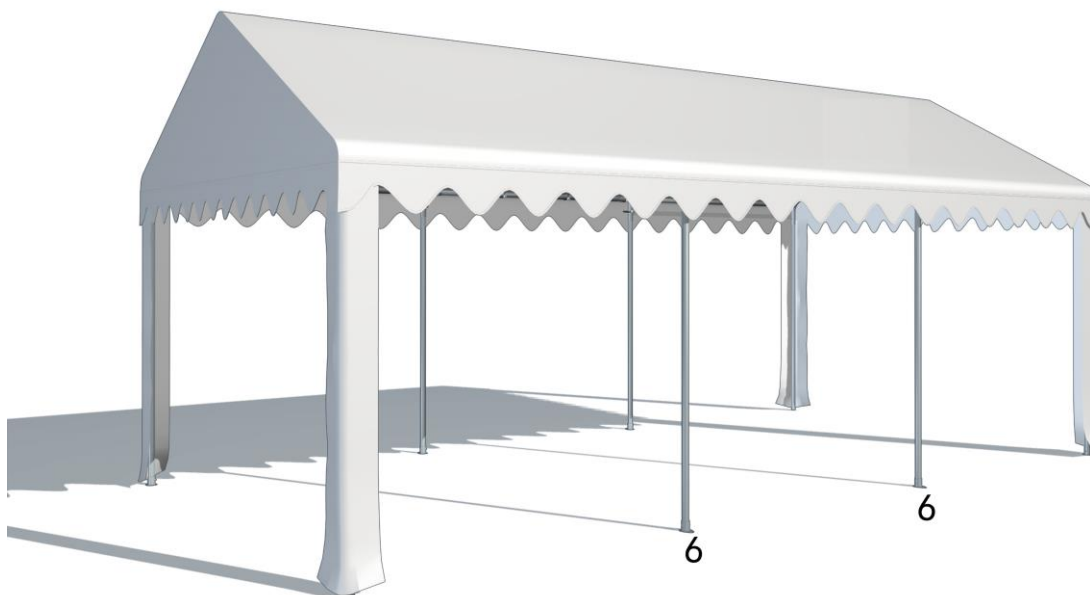

- 5.** Sæt alle sidevægge og gavle på teltet. Anvend elastikstropperne (del E) til sidevæggene. Elastikstropperne (del F) anvendes mellem taget og gavlene.

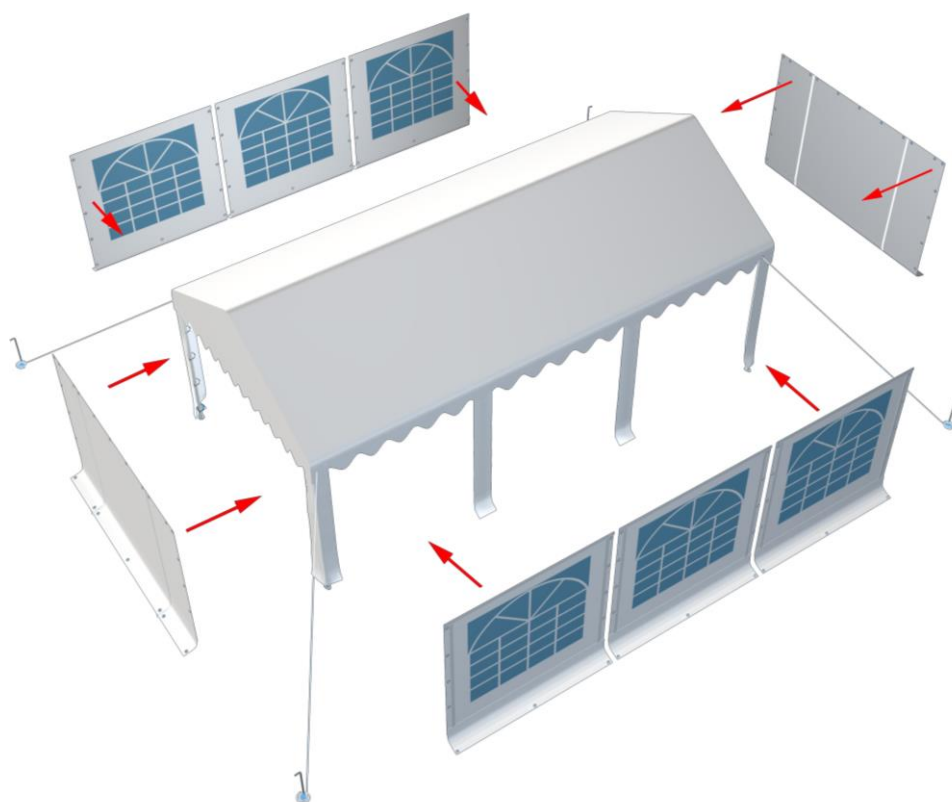

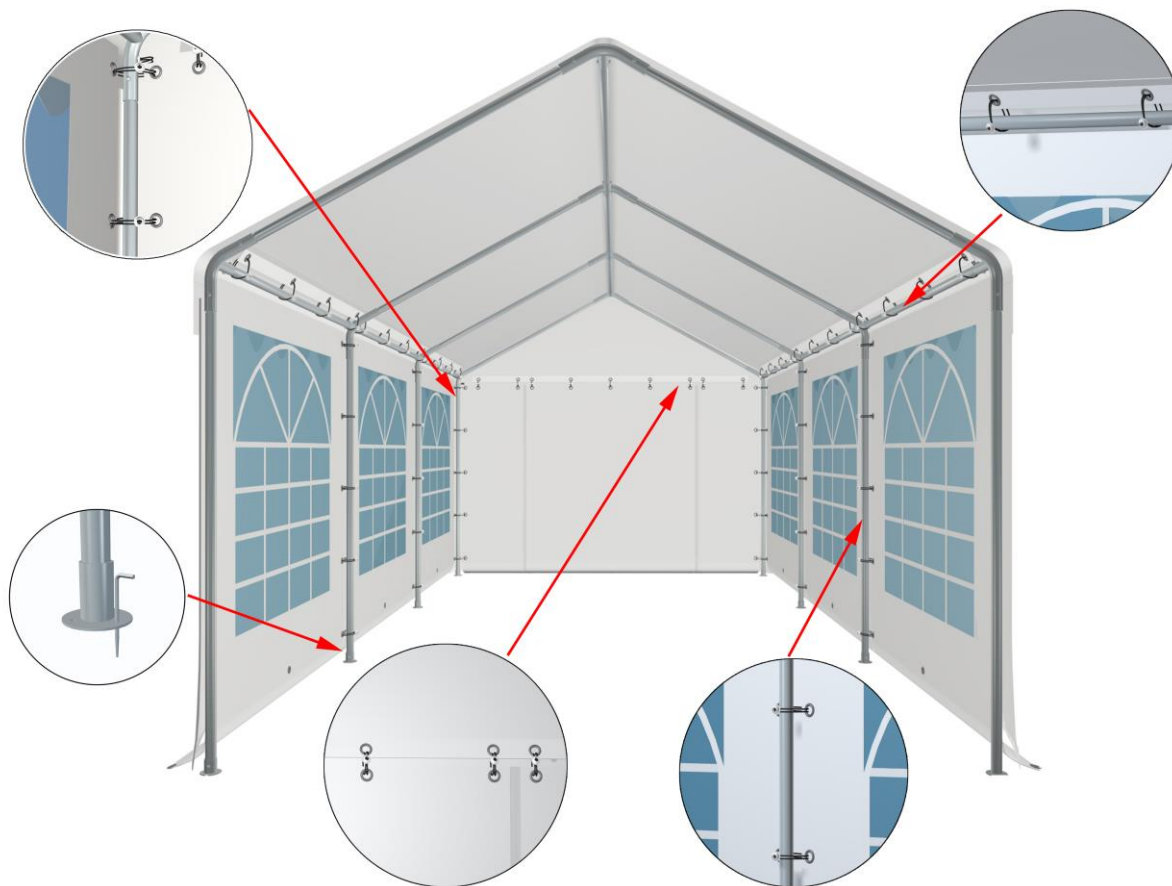

- 6.** Anvend barduner og jordankre til at gøre teltet mere stabilt. Monter bardunerne i teltstellet, ikke i dugen.
- 7.** Sæt de lange pløkke (B) i stellet's fødder og anvend de korte pløkke og anvend de korte pløkke (C) i øjerne på teltdugen.

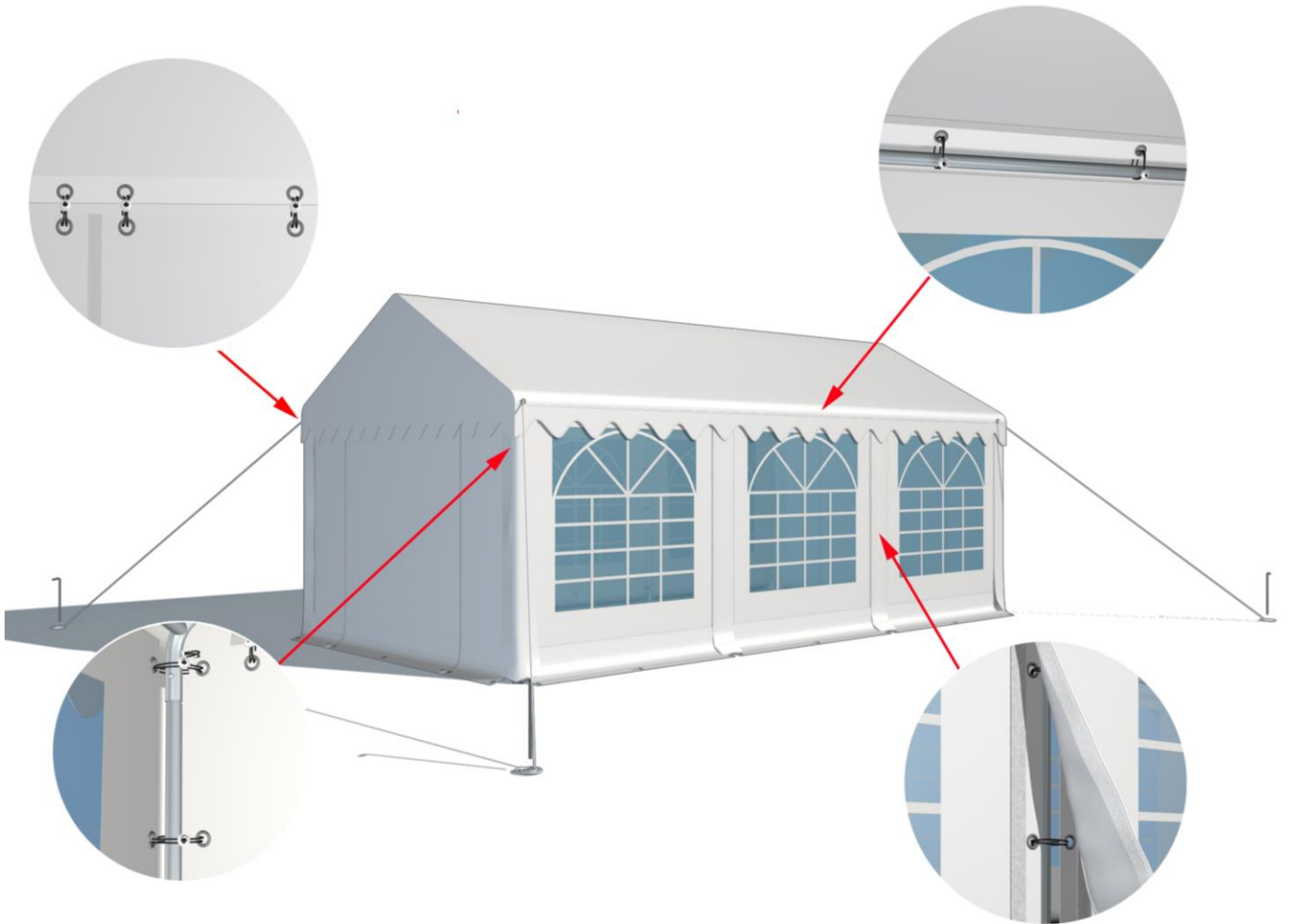

- 8.** Fastgør remserne der hænger ned fra taget med sidevæggene og gavlene med hjælp af de monterede velcro-remser.

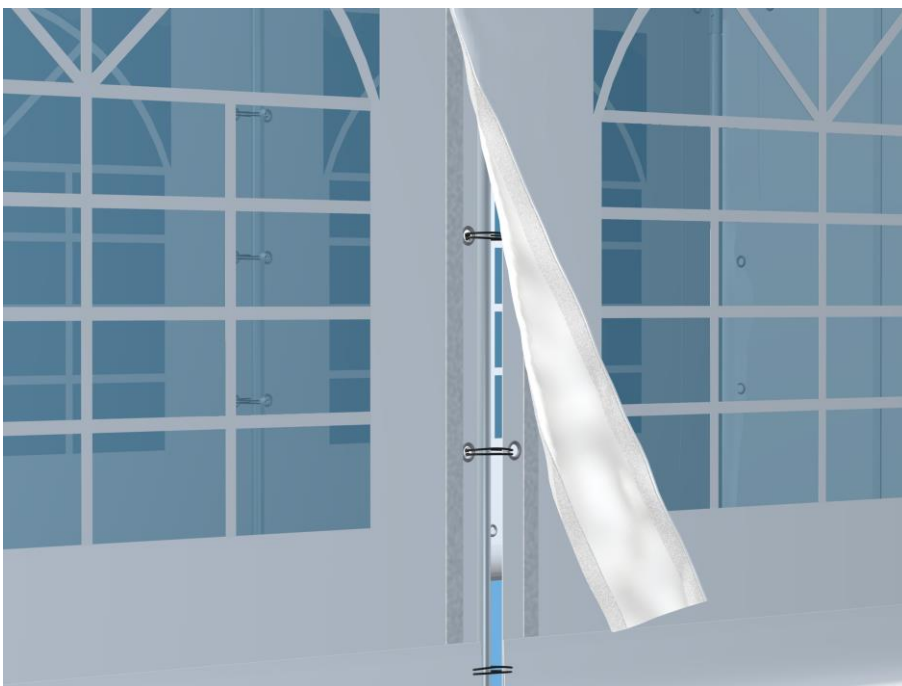

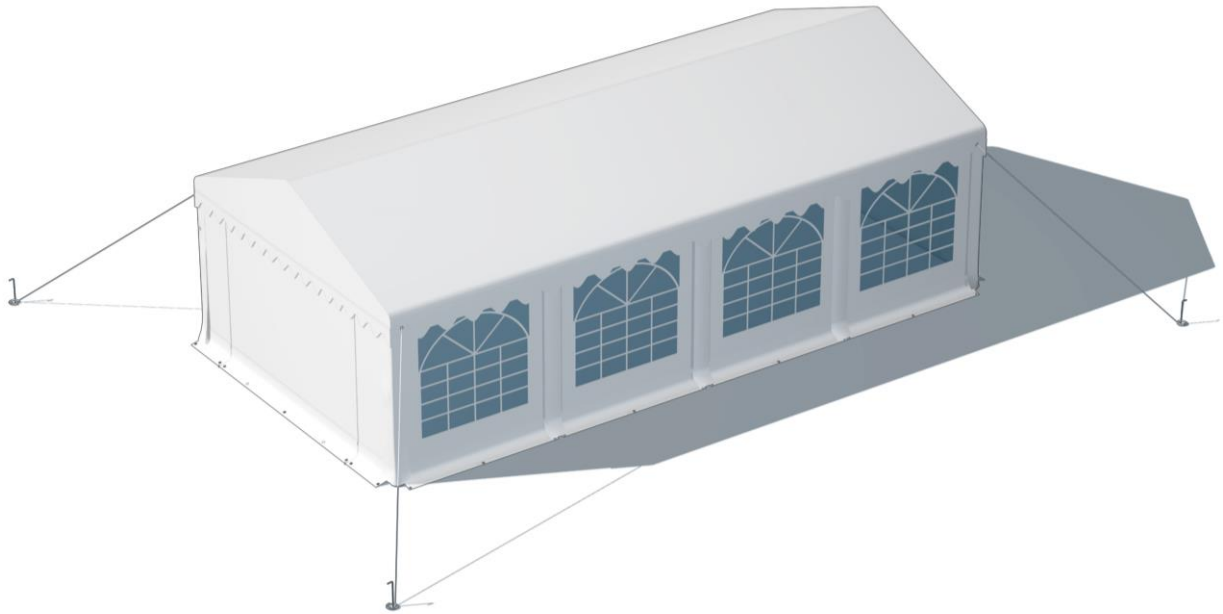









### **Vigtigt**

1. Vær forsigtig med delene under opsætning og nedtagning. Ellers kan de blive beskadiget.
2. Teltet er ikke konstrueret til at stå opsat i længere perioder. Hvis det bliver hårdt vejr skal det nedmonteres.
3. Find en egnet plads til teltet. Undgå sprinkleranlæg og kabler i jorden.
4. Selvom dette produkt er flammehæmmende skal man være forsigtig. Hold åben ild og andre varme kilder væk fra teltet.
5. Når teltet ikke anvendes skal det opbevares tørt.
6. Billederne der er brugt i denne manual er kun til illustration, og kan afvige fra den købte model.

# Bundramme 4 meter

Artikel-nummer		Beskrivelse	Antal	Antal	Antal	Antal
		Model	4X4m	4X6	4X8m	4X10m
1		Galvaniseret rør Længde 1940mm	8	10	12	14
5		Galvaniseret rør Længde 2190mm				
6		Galvaniseret rør Længde 1430				
12		Hjørnefod	4	4	4	4
13		Fod, langside	2	4	6	8
14		Fod, gavlside	2	2	2	2
BT		Skrue	22	28	34	40
BGX		Elastikstrop	12	14	16	18

- Følg monteringsvejledningen for teltet.
- Monter fødderne (12, 13) på teltbenene (3) i stedet for standardfødderne som følger med teltet.
- Monter herefter bundrammens rør på fødderne (12, 13, 14).
- Spænd sidevægge og gavle til bundrammen med elastikstropperne.